

# Sentinel

Kinetic MVHR

and

Kinetic Plus MVHR

Operation & Monitoring



## Stock Ref. N°

438222 Kinetic B  
438222A Kinetic BS  
443319 Kinetic BH  
443319A Kinetic S BH  
438342 Kinetic V  
438342A Kinetic VS  
443028 Kinetic Plus B  
447938 Kinetic Plus BS  
443029 Kinetic Plus CVP

***Vent-Axia***<sup>®</sup>

PLEASE RETAIN THESE INSTRUCTIONS WITH THE PRODUCT.



## IMPORTANT



**PLEASE READ THESE INSTRUCTIONS CAREFULLY BEFORE USING THE UNIT.**

1. THIS APPLIANCE IS NOT INTENDED FOR USE BY YOUNG CHILDREN OR INFIRM PERSONS WITHOUT SUPERVISION.
2. YOUNG CHILDREN SHOULD BE SUPERVISED TO ENSURE THAT THEY DO NOT PLAY WITH THE APPLIANCE.
3. DO NOT ATTEMPT TO REMOVE THE COVERS OF THIS UNIT. HIGH VOLTAGE IS PRESENT IN THIS UNIT.



### Disposal

This product should not be disposed of with household waste. Please recycle where facilities exist. Check with your local authority for recycling advice.

Software Ver 28

## Contents

<b>Product Description</b>	<b>3</b>
Sentinel Kinetic & Sentinel Kinetic Plus .....	3
Control Unit Display .....	5
Powering Up the Unit .....	7
Startup Screens .....	7
<b>Operation and Monitoring</b>	<b>8</b>
Overview .....	8
User Menu Screens .....	9
Boost & Purge Screens .....	11
Status Message Screens .....	12
<b>Maintenance</b>	<b>14</b>
Caring for the Unit .....	14
Filter Maintenance.....	14
12 Monthly Maintenance .....	14
Heat Exchanger Removal Instruction for CVP Unit.....	15
<b>Troubleshooting</b>	<b>17</b>
Diagnosing a Problem .....	17
<b>Appendix One: Control Mode 02 Description</b>	<b>18</b>
Overview .....	18
Airflow Mode Selection.....	18

## Product Description

### Sentinel Kinetic & Sentinel Kinetic Plus

The Vent-Axia **Sentinel Kinetic & Sentinel Kinetic Plus Mechanical Ventilation/Heat Recovery (MVHR)** is a heat recovery unit designed for the energy efficient ventilation of houses and similar dwellings, conforming to the latest requirements of the Building Regulations document F 2010.

The unit is designed for continuous 24 hour exhaust ventilation of stale moist air from bathrooms, toilets and kitchens. As the stale air is extracted, a heat exchanger within the unit transfers up to 90% of the heat into the supply air entering the bedrooms and lounge.

In addition a Kinetic Plus unit is available that maintains a constant air flow independent of change in the system pressure.

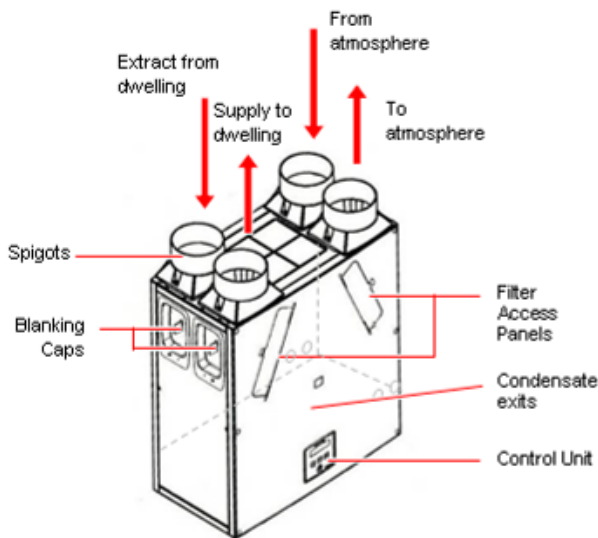

Figure 1: Sentinel Kinetic (Front of Unit as supplied)

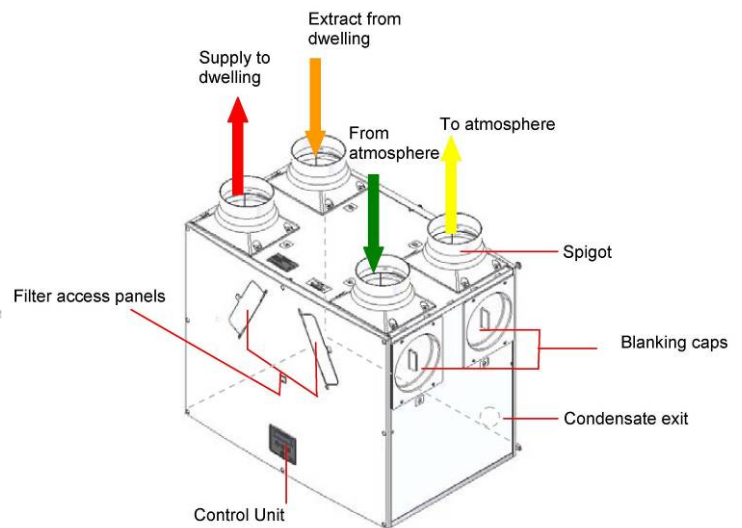

Figure 2: Sentinel Kinetic Plus (Front of Unit as supplied)

### Sentinel Kinetic Summer By Pass Models.

The Sentinel Kinetic B, BH, Plus B, Plus BS, S BH, BS and Plus CVP are fitted with a Summer By Pass (SBP) and will provide energy-free heating and energy-free cooling when the house temperature and ambient temperature allows.

If the room is warmer than the set (shown as "indoor") temperature (i.e. you need the room to be cooler) and the outdoor air is cooler than the actual room temperature (i.e. the outdoor air could cool your room) then the SBP will open and the unit will supply cooler air to your room.

If the room is cooler than the set ("indoor") temperature (i.e. you need the room heating) and the outdoor air is warmer than the actual room temperature (i.e. the outdoor air could heat your room) then the SBP will open and the unit will supply warmer air to your room.

Note that the above only applies whilst the outdoor air temperature is above 14 C (adjustable) in order to prevent cold draughts.

# Product Description

The set ("indoor") temperature should be set 2 or 3 degrees higher than the central heating thermostat and 2 or 3 degrees below any air conditioning thermostat if fitted. This will prevent any clash between the separate systems

## Models

- **438222** - Sentinel Kinetic **B** with summer bypass.
- **438222A** - Sentinel Kinetic **BS** with summer bypass.
- **443319** - Sentinel Kinetic **BH** with summer bypass and integral humidity sensor.
- **443319A** - Sentinel Kinetic **S BH** with summer bypass and integral humidity sensor
- **438342** - Sentinel Kinetic **V** without summer bypass.
- **438342A** - Sentinel Kinetic **VS** without summer bypass.
- **443028** - Sentinel Kinetic **Plus B** with Summer Bypass and integral humidity sensor.
- **447938** - Sentinel Kinetic **Plus BS** with Summer Bypass and integral humidity sensor.
- **443029** - Sentinel Kinetic **Plus CVP** (currently not available)

## Accessories

- **441838** - Sentinel Kinetic Plug-in integral humidity sensor
- **441865** - Wireless enable kit (consists of wireless receiver and one wireless switch).
- **437827** - Additional wireless switch (up to four may be connected).
- **441780** - Vent-Wise accessory pack.
- **442367** - Monza System Cooker Hood 600mm wide.
- **442368** - Latina System Cooker Hood 900mm wide
- **443283** - Remote Wired Control.
- **447340** – Opto coupler

A range of sensors can be used to manage system demand and control the ventilation rate. These include an internal humidity sensor, humidity sensors for independent mounting in rooms, wireless receiver and wireless boost switches, CO<sub>2</sub> sensor, Ventwise sensors, manual switches and pull cords. For these alternative control options, see [www.vent-axia.com](http://www.vent-axia.com)

## Control Unit Display

The Control Unit is located at the front of the Sentinel Kinetic unit. The Control Unit provides the user interface for commissioning and monitoring purposes.

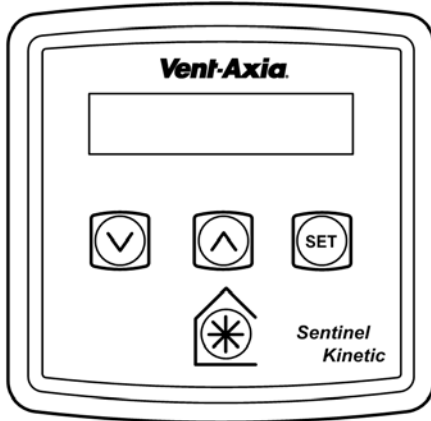
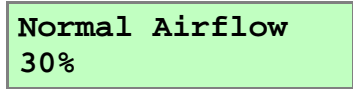

Figure 2: Control Unit

### Display

The main display is an LCD with automatic backlight, which is turned off to minimise power consumption when the unit is operational (see Overview on page 8).



### Buttons

Four buttons on the Control Unit provide the controls for configuring and monitoring the unit.

Table 1: Control Unit Buttons

Button	Function										
	Press to adjust settings and press to save settings.										
	Press to go to the above screen or to increase a parameter value. Press and hold for more than 2 seconds for fast scrolling.										
	Press to go to the next screen or to decrease a parameter value. Press and hold for more than 2 seconds for fast scrolling.										
	<p>Press to activate Boost mode.</p> <table border="1"> <thead> <tr> <th>No. of presses</th> <th>Boost action (Control Mode 01)</th> </tr> </thead> <tbody> <tr> <td>1</td> <td>Boosts for 30 minutes</td> </tr> <tr> <td>2</td> <td>Boosts for 60 minutes</td> </tr> <tr> <td>3</td> <td>Boosts continuously</td> </tr> <tr> <td>4</td> <td>Back to Normal flow rate</td> </tr> </tbody> </table> <p>Press and hold for 5 seconds to activate Purge mode. (Press and hold for 5 seconds to cancel Purge).</p>	No. of presses	Boost action (Control Mode 01)	1	Boosts for 30 minutes	2	Boosts for 60 minutes	3	Boosts continuously	4	Back to Normal flow rate
No. of presses	Boost action (Control Mode 01)										
1	Boosts for 30 minutes										
2	Boosts for 60 minutes										
3	Boosts continuously										
4	Back to Normal flow rate										

**N.B Additional airflow modes are available from the button when Control Mode 02 is selected in the start-up screens see Appendix One for further details.**

# Technical Specification

Performance	Sentinel Kinetic	Sentinel Kinetic Plus
<b>Airflow</b>	<b>Maximum, FID, 290 m<sup>3</sup>/h</b> <b>Low</b> default 20% <b>Normal</b> default 30% <b>Boost</b> default 50% <b>Purge</b> 100%	<b>Maximum, FID, 500 m<sup>3</sup>/h</b> <b>Low</b> default 20% <b>Normal</b> default 30% <b>Boost</b> default 50% <b>Purge</b> 100%
<b>Sound levels (@ 3 m)</b>	20 dB(A) (normal), 36 dB(A) (boost)	24 dB(A) (normal), 34 dB(A) (boost)
<b>Power</b>		
<b>AC Voltage Input</b>	220-240 V AC (single phase)	
<b>AC Frequency Input</b>	50 Hz nominal	
<b>Supply Fuse</b>	3 A (located in fused spur)	
<b>Product Fuse</b>	2 A (located on main PCB)	
<b>Rated Power</b>	150 W (max.)	190 W (max.)
<b>Physical</b>		
<b>Height (excluding spigots)</b>	550 mm	630 mm
<b>Width (excluding spigots)</b>	550 mm	775 mm
<b>Depth</b>	285 mm	520 mm
<b>Weight</b>	15 kg	24 kg
<b>Spigot diameter</b>	125 mm	150 mm
<b>Condensate pipe diameter</b>	22 mm	
<b>Environmental</b>		
<b>IP Rating</b>	IP22	
<b>Operating Temperature</b>	-20°C to +45°C	
<b>Air Intake Temperature</b>	As above	
<b>Operating Humidity</b>	0% to 95% RH	
<b>Storage Temperature</b>	-20°C to +45°C	
<b>Storage Humidity</b>	0% to 95% RH	
<b>Software Version</b>	V27	

For all other technical details, please see the Product Catalogue or our website at [www.vent-axia.com](http://www.vent-axia.com).

## Powering Up the Unit

### Switching On (The unit is designed to run continuously)

To switch the unit on:

1. Switch on the power at the mains supply isolator feeding the unit.
2. Following switch-on, the fan motors will start and the Control Unit will display a series of startup screens, described below.

### Switching Off

To switch the unit off: at the unit's local isolator, turn the power off.

## Startup Screens

### Sentinel Kinetic Version Screen

The Sentinel Kinetic Version screen displays the firmware version number for 3 seconds.

No adjustments are possible on this screen.

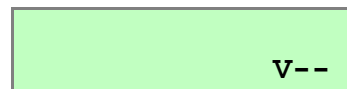

### Language Screen

The Language screen displays the language used for the screens. It is typically displayed for 5 seconds, or longer if changing the setting.

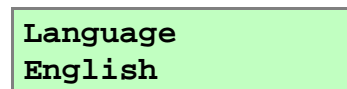

### Control Mode Screen

Selects between Control Mode 01 operation described herein and the alternative Control Mode 02 described in Appendix One.

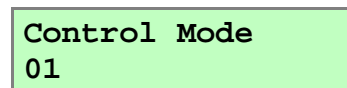

### Airflow Units Screen

The Airflow Units is a percentage of the unit's maximum flow.

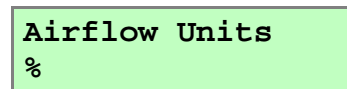

### Wireless Control Screen

The Wireless Control screen automatically displays whether the wireless boost control switch is fitted. It is typically displayed for 3 seconds.

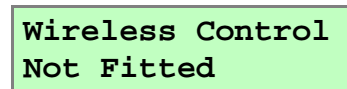

### Humidity Sensor Screen

The Humidity Sensor screen displays whether the humidity sensor is fitted. It is typically displayed for 3 seconds.

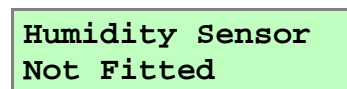

## Operation and Monitoring

### Overview

When the Sentinel Kinetic unit has been installed and commissioned it should require no further intervention in order to operate, unless external switches are used to control on/off/boost, etc, or BMS control requires user action.

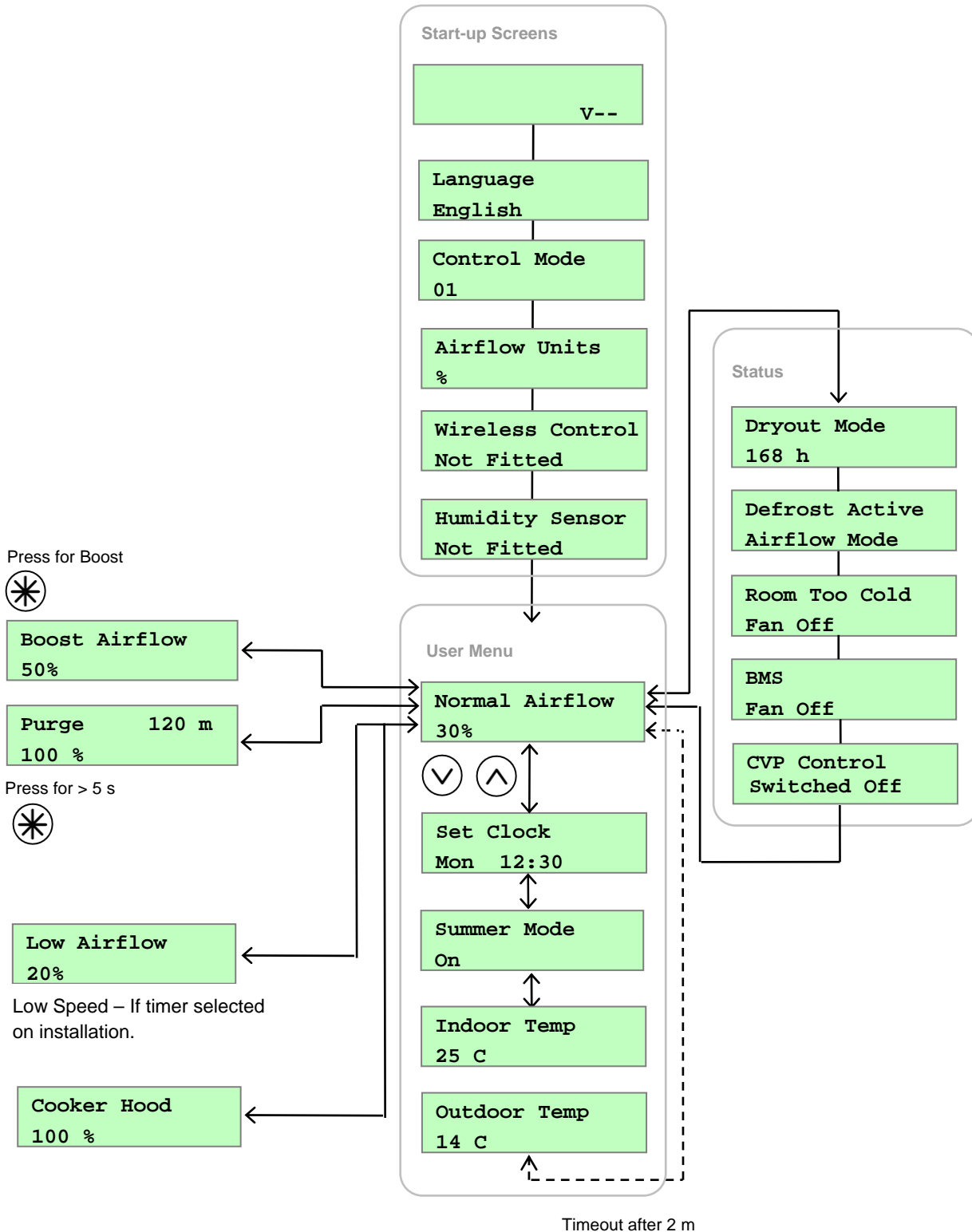











## User Menu Screens

From the Normal Airflow screen, press the  button to access the rest of the User Menu screens.

Changing the value of a setting (if adjustable) is typically a 3-step procedure:

1. Press  to select the setting (the setting will flash).
2. Use the  or  buttons to adjust the value. To scroll quickly, press and hold the  or  buttons for more than 2 seconds.
3. Press  again to enter the new settings and move to the next screen.

To return to the Normal Airflow screen, press the  button repeatedly or press and hold the  button for 5 seconds. Alternatively, the Normal Airflow screen will be restored if no buttons are pressed for two minutes (timeout). Settings are stored in a the memory and will be retained in the event of mains power supply failure.

### Low Airflow / Normal Airflow / Boost Airflow Screen

When the start-up screens are finished, the Low or Normal screen is displayed showing operating status (Low Airflow X % or Normal Airflow X % or Boost Airflow X %).

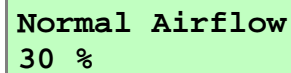

Normal Airflow  
30 %

The Normal screen displays the rate of normal airflow (supply air) through the unit.

If the installation has proportional sensors or an internal humidity sensor fitted, an  $\alpha$  symbol will be displayed when they are boosting the airflow.

When the summer bypass is active, the normal screen top line will alternate (for 3 seconds) with Summer Bypass.

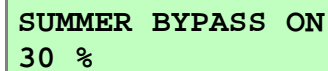

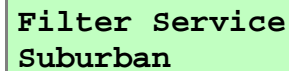

SUMMER BYPASS ON  
30 %

An interval can be set, see page 38 of the Installation and Commissioning manual, at which the unit reminds the user to check the filters. This will be 6, 12 or 18 months. The normal screen top line will include Check Filter as a reminder to check and, if necessary, clean or replace the filters.



Filter Service  
Suburban

When this has been done, press and hold the  and  buttons for 5 seconds to reset the automatic message.

## Set Clock Screen

From the Normal Airflow screen, simply press the  button once to access the Set Clock screen.

The Set Clock Control screen enables you to change the clock settings. The clock retains its settings for approximately two weeks without mains power, after which it will need resetting when power is reconnected

Values are **DDD HH:MM**.

Return to the normal display by pressing the  button or leave to timeout and return automatically after 2 minutes.

The unit will not automatically switch for Daylight saving time.



## Summer Mode Screen

From the Set Clock screen, simply press the  button twice to access the Summer Mode screen.

If the unit is a summer bypass model, the Summer Mode screen enables you to switch the summer bypass control on or off. This screen is only displayed when the bypass is fitted.

Options available are **On** (default) and **Off**.

Return to the normal display by pressing the  button or leave to timeout and return automatically after 2 minutes.

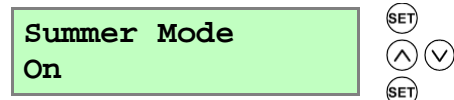

## Indoor Temp Screen

From the Summer Mode screen, simply press the  button 3 times to access the Indoor Temp screen.

The Indoor Temp screen enables you to choose the target room temperature in degrees Centigrade – only displayed when the bypass is fitted.

Selectable range is **16-40** (**25** default).

Return to the normal display by pressing the  button or leave to timeout and return automatically after 2 minutes.

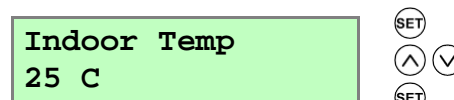

## Boost & Purge Screens

### Boost Screen

Pressing the  button activates boost airflow mode when extra ventilation is required.

**Boost Airflow**  
50 %

No. of presses	Boost action (Control Mode 01)
1	Boosts for 30 minutes
2	Boosts for 60 minutes
3	Boosts continuously
4	Back to Normal flow rate

**N.B Additional airflow modes are available from the  button when Control Mode 02 is selected in the start-up screens see Appendix One for further details.**

If the wireless boost option is fitted, this can be triggered from the wireless transmitter/boost switch.

If the installation has switch sensors, is wired to the lighting, has Vent-Wise sensors or if the internal time switch is set for periodic operation, operation will change from normal to boost automatically. Pressing the  button will reveal a code to show which device has activated boost.

s1 = Switch S/W1

s2 = Switch S/W2

s3 = Switch S/W3

s4 = Switch SW4

s5 = Switch SW5

v1 = Vent-Wise Input S/W1

v2 = Vent-Wise Input S/W2

v3 = Vent-Wise Input S/W3



ls = Switched live (LS)

w1-4 = Wireless controller

c1-3 = Internal Time switch

If running on boost due to pressing the  button, a device will 'take over' the boost. Flow will return to low / normal when that device switches off. If a number of different devices are calling for boost flow, the unit will run at boost until the last one has reverted to normal.

## Purge Screen

Pressing and holding the  button for 5 seconds activates purge mode when you want to purge air from the building. The unit will revert to normal flow by pressing and holding the  button again for 5 seconds. If the wireless boost option is fitted, this can be triggered from the wireless transmitter/boost switch.

Purge mode runs the fans at full speed for 2 hours (120 minutes). The Purge screen displays a countdown of the time remaining.

<b>Purge</b>	<b>120m</b>
<b>100 %</b>	

## Cooker Hood Boost Screen

There is a separate connection for a cooker hood control which allows the boost level to be higher when triggered by a Cooker Hood.

<b>Cooker Hood</b>
<b>100 %</b>

## Low Airflow Screen



Low Airflow mode is activated when the Normal Airflow is set to **Off**, (see page 31 in the Installation and Commissioning manual for set up details).

The Normal Airflow mode can be set to run during the daytime i.e. from 6am to 11pm, the Low Airflow mode will then run during the night from 11pm to 6pm.

<b>Low Airflow</b>
<b>20 %</b>

## Status Message Screens

The status message screens override the Normal Airflow and other user screens, and display status and key operational conditions (temperatures or pressures, etc.) according to how the unit has been configured. If there is more than one status item to be displayed, the highest priority message is shown.

These screens are displayed in a loop during normal operation of the unit, either after displaying the start-up screens, or when commissioning has been completed. After a few seconds the display backlight is turned off in order to minimise power consumption. The  and  buttons can be used to stop the loop sequence in order to display individual screens for a longer period with the backlight turned on, if required.

## Dryout Mode Screen

The Dryout Mode screen displays the time remaining for the building to dry out. The unit runs at maximum flow for 1 week.

<b>Dryout Mode</b>
<b>168 h</b>

## Defrost Active Screen

The Antifrost screen is only displayed if a summer bypass is fitted. In installations where a negative pressure is not permitted during antifrost operation, set this to bypass mode.

Available options: **Airflow Mode** (default) and **Bypass Mode**.

**Airflow Mode** - When the supply air temperature is between 0° and -20°C, antifrost will automatically activate. This will reduce the supply airflow rate and increase the extract airflow rate to prevent frost forming on the heat exchanger. During antifrost operation the supply motor can stop for 15 minutes and run for 45, depending on the temperature below 0°C. If the supply air temperature is -20°C or below the supply fan switches off and the extract fan continues to run at reduced rate to prevent frost forming on the heat exchanger.

**Bypass Mode** - While the supply air temperature is below 0°C, the antifrost mode will automatically activate. This mode will open the bypass to prevent frost forming on the heat exchanger.

Defrost Active  
Airflow Mode

## Room Too Cold Screen

The Room Too Cold screen displays the status of the fan. If the heating system in the building fails or is switched off and the internal temperature drops below 5°C, the unit will stop running so as to not bring cold air into an already cold house. The unit will start up every hour and will run for a short time to measure the temperature of the property. When the temperature rises, e.g. the heating system is switched back on, the unit will restart and continue normal operation.

Bottom line of display may be ( **Fan Off, Fan Restarting**).

Room Too Cold  
Fan Off

## BMS Screen

The BMS screen shows if a Fan Off command has been received from a Building Management System (BMS), if used.

A **Fan Off** command could be received from the BMS in the event of a fire alarm.

BMS Mode  
Fan Off

## CV Failure

The Fault Code screen is displayed when the Constant Volume stops working.



CV Control  
Switched Off

## Maintenance



### Caring for the Unit

Heat recovery units, by their very nature, require regular maintenance. The Sentinel Kinetic has been designed to facilitate access to enable maintenance to be carried out easily.

### Filter Maintenance

Item	Action
Fan Filters	<p>When the unit displays “Check filters”. This is a reminder to ensure that the filters are not so dirty that they are blocking the airflow or allowing dirt to pass through. The rate at which the filters become dirty will vary hugely depending on the environment and the activity within the property.</p> <ol style="list-style-type: none"> <li>1. Open the filter flaps and remove the 2 filters.</li> <li>2. Clean gently by tapping or carefully using a vacuum cleaner if necessary.</li> <li>3. Replace the filters</li> <li>4. Close the filter flaps.</li> <li>5. Reset the automatic message, press and hold the  and  buttons for 5 seconds.</li> </ol>

### 12 Monthly Maintenance

Item	Action
Fan Filters (Interval to suit environment)	<p>Change the Fan Filters depending on which environment the unit has been installed; urban, suburban or rural.</p> <ol style="list-style-type: none"> <li>1. Open the filter flaps and remove the 2 filters.</li> <li>2. Insert the replacement filters.</li> <li>3. Close the filter flaps.</li> <li>4. Reset the automatic message, press and hold the  and  buttons for 5 seconds.</li> </ol>
Unit & Heat Exchanger Cell	<p>Inspect and clean the unit</p> <ol style="list-style-type: none"> <li>1. <b>Isolate the mains power supply.</b></li> <li>2. Remove front cover from the unit.</li> <li>3. Remove the 2 filters.</li> <li>4. Slide out the heat exchanger. <i>For Sentinel Kinetic Plus CVP refer to pages 15 and 16.</i></li> <li>5. Wash the outer cover and heat exchanger in warm water using a mild detergent (such as Milton Fluid) and dry thoroughly.</li> </ol> <p><b>NOTE: Keep water away from all electrical components and wiring within the unit.</b></p>
Motors	<p>Inspect the motors for build-up of dust and dirt on the impeller blades, which could cause imbalance and increased noise levels. Vacuum or clean if necessary.</p>
Condensate Drain	<p>Check the condensate drain tube is secure and clear of debris. Clean if necessary.</p>
Fastenings	<p>Check that all unit and wall-mount fastenings are sufficiently tight and have not become loose. Re-tighten if necessary.</p>
CV Control Switched Off	<p>This can be caused either by a trapped pressure tube/s or by faulty sensors.</p>

## Heat Exchanger Removal Instruction for CVP Unit

1. Remove the 8 screws and detach the front cover and then pull out both filters.

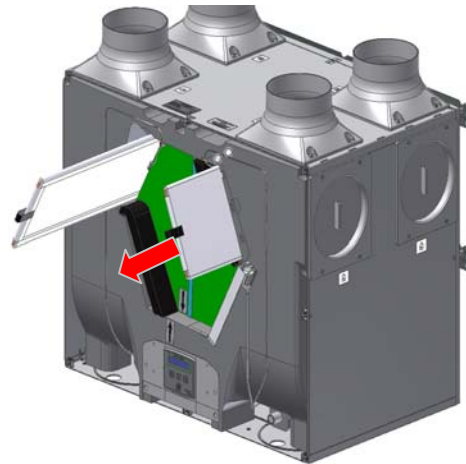

2. Remove both pressure tubes from their channels and let them remain suspended in the air as shown opposite.

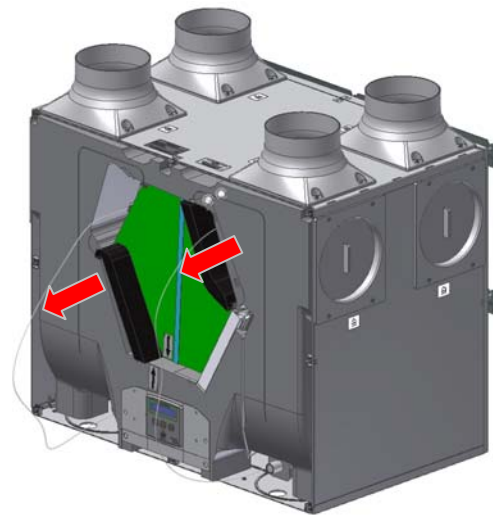

3. Pull out the Heat Exchanger Cell to gain access to the 2 screws on the cell as shown opposite. Loosen up the both screws (no need to remove them completely) to be able to remove the pressure tube and its rubber grommet strip.

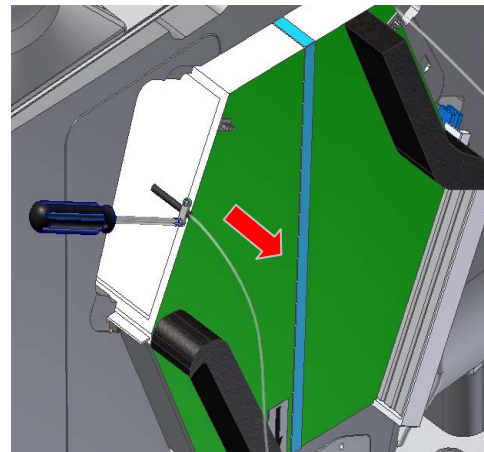

4. Pull out the cell and make sure that the rear bottom of the cell is securely resting on the lower edge of the foam so you can access the rear pressure tube. Repeat step 3 to detach the rear pressure tube. When the rear pressure tube is removed then the cell is free to clean.

**Once the cell is cleaned then attach the pressure tubes in reverse order starting from step 4 to 1. Do not over tighten the screws for securing clips. The clips should just slightly grip the rubber grommet strips as over tightening of the clips can block the air pressure.**

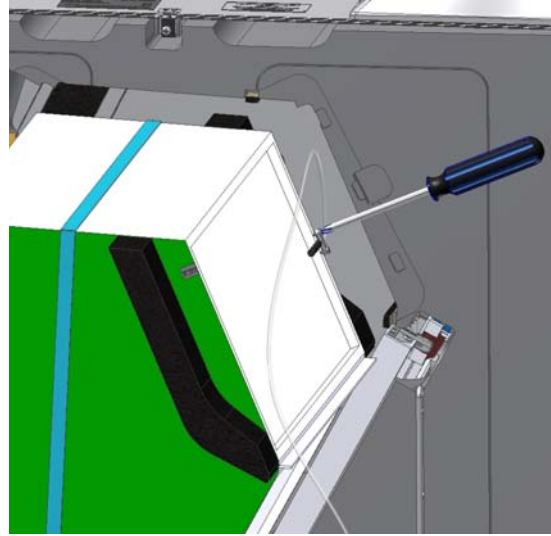



## Troubleshooting

### Diagnosing a Problem

In the event of a problem, always troubleshoot the unit according to:

- **Fault code** displayed on the Control Unit or Remote Wired Control.
- **Fault LED** if connected.

If no indications are displayed, then troubleshoot problem according to the fault symptom as described in the following tables.

#### Service/Fault Code Screens

The Service screen is displayed, alternating with the Fault Code screen, when a fault has caused the unit to switch off and you must phone the telephone number displayed on the screen for assistance.

**Service Phone**  
01293nnnnnn

The Fault Code screen is displayed, alternating with the Service screen, when a fault has occurred. Take note of the fault code when reporting a fault.

**Fault Code**  
01

For assistance contact the service provider and quote the fault code number. The following fault codes numbers may be displayed. Code numbers are added together if more than one is detected.

Table 2: Fault Codes

Code	Problem
01	Supply Fan not running
02	Extract Fan not running
04	Control PCB 24 V fuse (FS1) failure
08	Temperature sensor T1 (supply) faulty
16	Temperature sensor T2 (extract) faulty
32	Wired Remote Control failure

## Appendix One: Control Mode 02 Description

### Overview

The functional differences described in this Appendix are available when Control Mode 02 is selected from the start-up screens. Control Mode 02 assigns alternative functions to certain wiring Terminal Connections (described in Appendix One of the Installation and Commissioning Manual) and allows additional airflow settings to be accessed via the  button on the front of the Kinetic unit or remote control as shown below:

### Airflow Mode Selection

The following switching Functions are available via the  button with Control Mode 02:

No. of presses	Airflow Mode (Control Mode 02)
1	Low
2	Normal
3	Boosts 30 minutes
4	Boosts 60 minutes
5	Boosts continuously
6	Cancel

Press  10 seconds after last press to cancel and return to normal operation.

If the wireless boost option is fitted, this can be triggered from the wireless transmitter/boost switch.

If the installation has switch sensors, is wired to the lighting, has Vent-Wise sensors, Vent-Wise momentary switch or if the internal time switch is set for periodic operation, operation will change from normal to boost automatically. Pressing the  button will reveal a code to show which device has activated boost.

s4 = Switch SW4

v1 = Vent-Wise Input S/W1

v2 = Vent-Wise Input S/W2

v3 = Vent-Wise Input S/W3

ls = Switched live (LS)

w1-4 = Wireless controller

c1-3 = Internal Time switch

If running on boost due to pressing the  button, another device may 'take over' the boost. Flow will return to normal when that device switches off. If a number of different devices are calling for boost flow, the unit will run at boost until the last one has reverted to normal.



## The **Vent-Axia** Guarantee

Applicable only to products installed and used in the United Kingdom. For details of guarantee outside the United Kingdom contact your local supplier.

Vent-Axia guarantees its products for two years from date of purchase against faulty material or workmanship. In the event of any part being found to be defective, the product will be repaired, or at the Company's option replaced, without charge, provided that the product:-

- Has been installed and used in accordance with the instructions given with each unit.
- Has not been connected to an unsuitable electricity supply. (The correct electricity supply voltage is shown on the product rating label attached to the unit).
- Has not been subjected to misuse, neglect or damage.
- Has not been modified or repaired by any person not authorised by the company.

### IF CLAIMING UNDER TERMS OF GUARANTEE

Please return the complete product, carriage paid to your original supplier or nearest Vent-Axia Centre, by post or personal visit. Please ensure that it is adequately packed and accompanied by a letter clearly marked "Guarantee Claim" stating the nature of the fault and providing evidence of date and source of purchase.

# **Vent-Axia**

Head Office: Fleming Way, Crawley, West Sussex, RH10 9YX.

**UK NATIONAL CALL CENTRE**, Newton Road, Crawley, West Sussex, RH10 9JA

SALES ENQUIRIES: Tel: 0844 8560590 Fax: 01293 565169

TECHNICAL SUPPORT Tel: 0844 8560594 Fax: 01293 532814

For details of the warranty and returns procedure please refer to [www.vent-axia](http://www.vent-axia) or write to Vent-Axia Ltd, Fleming Way, Crawley, RH10 9YX